

TECHNICAL INFORMATION
SD-28

Characteristics and use of --- Si APD (Avalanche Photodiode)

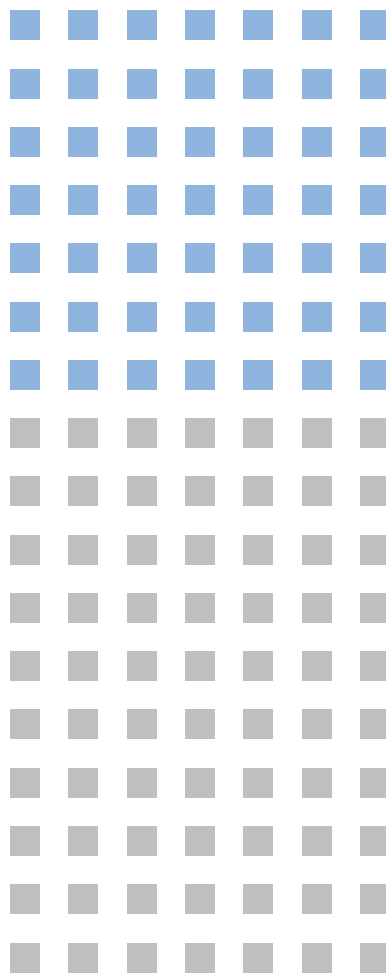

Table of contents

Si APD selection guide	3
1. Basic characteristics of Si APD	4
1-1 Principle of avalanche multiplication	4
1-2 Dark current vs. reverse voltage	4
1-3 Gain vs. reverse voltage	5
1-4 Spectral response	5
1-5 Terminal capacitance	5
1-6 Noise	5
1-7 Response speed	6
1-8 Connection to peripheral circuits	7
2. Near infrared Si APD	8
(low-bias operation type, low temperature coefficient type)	
2-1 Structure	8
2-2 Dark current vs. reverse voltage	8
2-3 Gain vs. reverse voltage	8
2-4 Spectral response	9
2-5 Terminal capacitance	10
2-6 Noise	10
2-7 Frequency response	10
3. Short-wavelength type Si APD	11
3-1 Structure	11
3-2 Dark current vs. reverse voltage	11
3-3 Gain vs. reverse voltage	11
3-4 Spectral response	11
3-5 Terminal capacitance	12
3-6 Noise	12

Characteristics and use of Si APD (Avalanche Photodiode)

Si APD selection guide

Type No.	Package	Active area *1 (mm)	Spectral response range λ (nm)	Peak *2 sensitivity wavelength λ_p (nm)	Quantum efficiency M=1 $\lambda=\lambda_p$ (%)	Breakdown voltage V _{BR} I _D =100 μ A		Dark current I _D Max. (nA)	Cut-off *2 frequency f _c R _L =50 Ω (MHz)	Terminal *2 capacitance C _t (pF)	Gain M
						Typ. (V)	Max. (V)				

Low-bias operation type, 800 nm band (for near infrared detection)

S2381	TO-18	ϕ 0.2	400 to 1000	800	75	150	200	0.5	1000	1.5	100 ($\lambda=800$ nm)	
S2382		ϕ 0.5						1	900	3		
S5139	(lens)							ϕ 1.0	2	600		6
S8611		TO-5							ϕ 1.5	5		400
S2383	ϕ 3.0							10	120	40		
S2383-10	TO-8							ϕ 5.0	30	40		95
S3884								60 ($\lambda=800$ nm)				
S2384								40 ($\lambda=800$ nm)				
S2385												

Low temperature coefficient type, 800 nm band (for near infrared detection)

S6045-01	TO-18	ϕ 0.2	400 to 1000	800	75	200	300	0.5	1000	1.5	100 ($\lambda=800$ nm)
S6045-02		ϕ 0.5						1	900	3	
S6045-03		ϕ 1.0						2	600	6	
S6045-04	TO-5	ϕ 1.5						5	350	12	
S6045-05		ϕ 3.0						10	80	50	
S6045-06	TO-8	ϕ 5.0						30	35	120	

Short-wavelength type

S5343	TO-18	ϕ 1.0	200 to 1000	620	80	150	200	5	250	15	50 ($\lambda=650$ nm)
S5344	TO-5	ϕ 3.0						30	25	120	
S5345	TO-8	ϕ 5.0						100	8	320	

*1: Effective area in which multiplication occurs.

*2: Measured at a gain listed in this characteristic table.

Hamamatsu also provides APD modules (C5331 series) that operate by simply supplying +5 V and a thermoelectrically-cooled APD modules, etc. for highly stable operation.

Figure 1 Spectral response

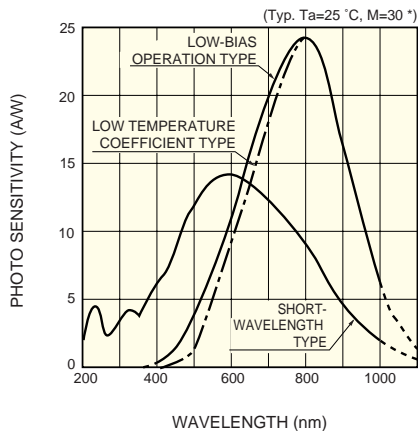

Figure 2 Breakdown voltage temperature coefficient vs. ambient temperature

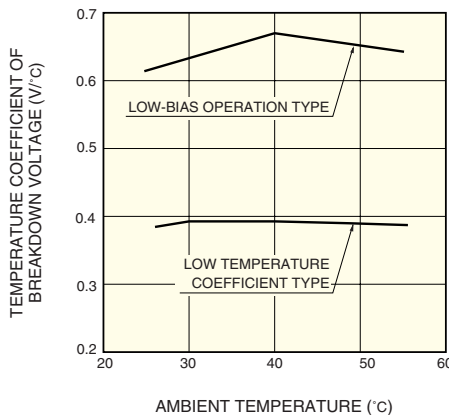
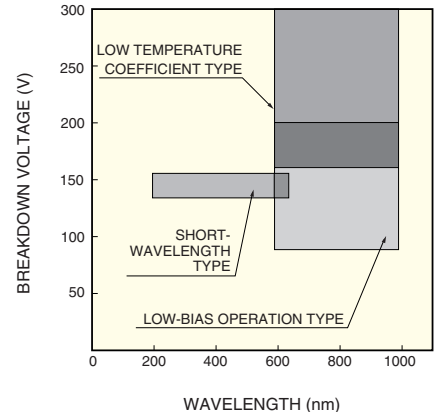

Figure 3 Breakdown voltage vs. wavelength



* Measured with a reverse bias voltage that provides a gain of 30 when light at 650 nm wavelength enters the APD.

KAPDB0007EE

KAPDB0031EC

KAPDB0032EC

1. Basic characteristics of Si APD

APDs (Avalanche Photodiodes) are high-speed, high sensitivity photodiodes utilizing an internal gain mechanism that functions by applying a reverse voltage. Compared to PIN photodiodes, APDs can measure even lower level light and are used in a wide variety of applications requiring high sensitivity such as long-distance optical communications and optical distance measurement.

Hamamatsu provides various types of APD families including those designed for near infrared or short-wavelength detection, allowing you to choose the desired devices that match your application.

1-1 Principle of avalanche multiplication

When light enters a photodiode, electron-hole pairs are generated if the light energy is higher than the band gap energy. Light energy E (eV) and wavelength λ (nm) have a particular relation as shown in Equation 1-1 below.

$$\lambda = \frac{1240}{E} \text{ (nm)} \dots (1-1)$$

The band gap of a Si is 1.12 eV at room temperatures, so that it is sensitive to light wavelengths shorter than 1100 nm. This sensitivity is commonly expressed by terms called photosensitivity S (A/W) and quantum efficiency QE (%). The photosensitivity is the photocurrent divided by the incident radiant power, expressed in A/W. The quantum efficiency is the ratio of electron-hole pairs generated versus the number of incident photons. These two terms have the following relation.

$$QE = \frac{S \times 1240}{\lambda} \times 100 \text{ (%) } \dots (1-2)$$

When electron-hole pairs are generated in the depletion layer of a photodiode with a reverse voltage applied to the PN junction, the electrons drift towards the N+ side while the holes drift towards the P+ side due to the electric field developed across the PN junction. The drift speed of these electron-hole pairs or carriers depends on the electric field strength. However, when the electric field is increased to a certain level, the carriers are more likely to collide with the crystal lattice so that their drift speed becomes saturated at an average speed. This phenomenon begins to occur when the electric field is in the vicinity of 10^4 V/cm, and the saturated drift speed at this point is about 10^7 cm/s. If the reverse voltage is increased even further, some of the carriers which escaped collision with the crystal lattice will have a great deal of energy. When these carriers collide with the crystal lattice, ionization in which electron-hole pairs are newly generated takes place. These electron-hole

pairs then create additional electron-hole pairs in a process just like a chain reaction. This is a phenomenon referred to as avalanche multiplication of photocurrent. This phenomenon begins to take place when the electric field strength reaches 2×10^5 V/cm. Figure 1-1 is the schematic diagram of an avalanche process showing how the generated carriers are multiplied inside the APD.

Figure 1-1 Schematic diagram of avalanche process

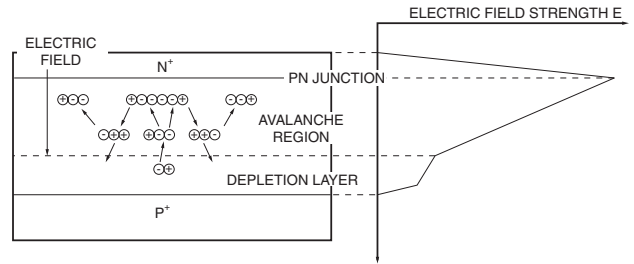

KAPDC0006EA

The number of electron-hole pairs generated during the time that the carriers travel a given distance is referred to as the ionization rate. Usually, the ionization rate of electrons is defined as α and that of holes as β . These ionization rates are important factors in determining the avalanche multiplication mechanism. The ratio k of β to α is called the ionization ratio and is used as a parameter to indicate device noise. (See Equation 1-3.)

$$k = \frac{\beta}{\alpha} \dots (1-3)$$

1-2 Dark current vs. reverse voltage

The APD dark current is categorized into: surface leakage current I_{ds} flowing through the interface between the PN junction and Si oxide layer and internal current I_{dg} generated inside the Si substrate. (See Figure 1-2.)

Figure 1-2 APD dark current

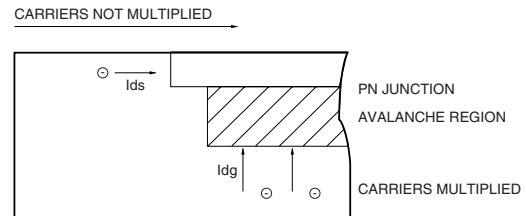

KAPDC0011EA

The surface leak current is not multiplied because it does not flow in the avalanche region, but the internally generated current flows in the avalanche region so it is multiplied. The total dark current I_D produced from an APD becomes as follows.

$$I_D = I_{ds} + M \cdot I_{dg} \dots (1-4)$$

Where M is the multiplication ratio or gain.

Figure 1-3 graphically shows how the dark current changes

with the reverse voltage. It is clear that I_{dg} increases as the reverse voltage rises.

Figure 1-3 Dark current vs. reverse voltage

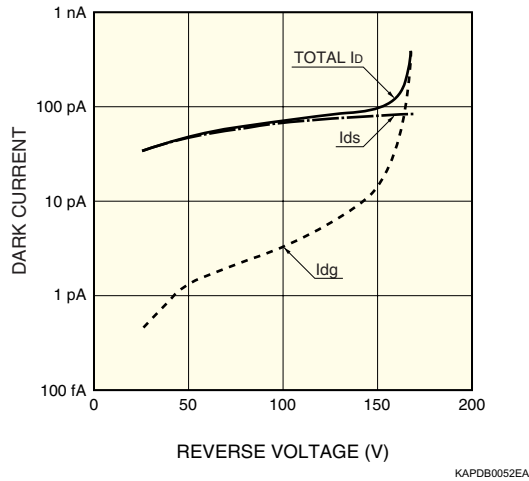

1-3 Gain vs. reverse voltage

The APD multiplication ratio (gain) depends on the electric field applied across the avalanche layer. Normally, the higher the reverse voltage, the higher the gain will be. However, if the reverse voltage is increased further, a voltage drop occurs due to the current flowing through the device series resistance and load resistance, causing the voltage applied to the avalanche layer to decrease. This means that the APD has a maximum gain whose value is dependent on the photocurrent. When the APD is operated near this maximum gain, the voltage drop tends to increase due to the series resistance component, resulting in an unwanted phenomenon in which the output photocurrent is not proportional to the amount of incident light.

The APD gain also has temperature-dependent characteristics. The gain at a certain reverse voltage becomes small as the temperature rises. This is because the crystal lattice vibrates more heavily with an increasing temperature, and the accelerated carriers are apt to collide with the lattice before reaching an energy level sufficient to trigger ionization. To obtain a constant output, it is necessary to adjust the reverse voltage according to the changes in temperature or to keep the APD temperature constant. The temperature coefficient of gain is commonly expressed in $V/^\circ C$ or $\%/^\circ C$. When an APD is operated at a gain of 100, the temperature coefficient of the reverse voltage will be almost equal to that of the breakdown voltage.

1-4 Spectral response

Spectral response characteristics of APDs are almost the same as those of normal photodiodes if a reverse voltage is not applied. When a reverse voltage is applied, the spectral response curve will change slightly. This is because the multiplication efficiency of carriers injected into the avalanche re-

gion depends on the wavelength. This means that the gain changes depending on the incident light wavelength. It is therefore important to select an APD with spectral response characteristics that match your application.

1-5 Terminal capacitance

APDs have the same terminal capacitance characteristics as those of normal photodiodes. To ensure high-speed response, it is necessary to apply a reverse voltage which makes the depletion layer thicker than the penetration depth of the light into the light absorption layer. If carriers are generated outside the depletion layer, they cause problems such as slow signal decay time. Since the terminal capacitance depends on the depletion layer thickness, it can be used as a guide to find to what extent the semiconductor substrate is depleted.

Unlike the gain characteristics, the terminal capacitance is not temperature-dependent. However, it does vary depending on the reverse voltage, as shown in region ① of Figure 1-4. So use the APD at a reverse voltage that ensures a constant terminal capacitance as in region ②.

Figure 1-4 Terminal capacitance vs. reverse voltage

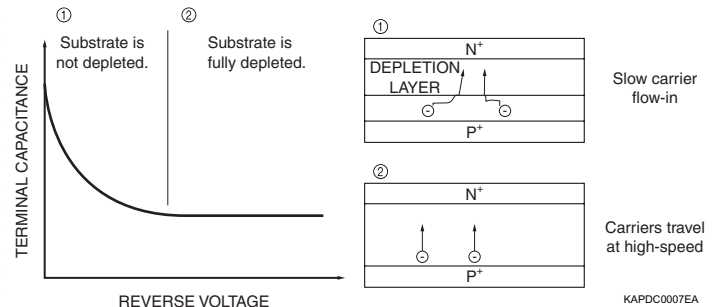

1-6 Noise

The APD multiplication process contains statistical fluctuations. When the reverse voltage is constant, the gain becomes constant. However, the ionization of individual carriers is not uniform so that multiplication noise known as “excess noise” is added during the multiplication process. Therefore, the APD shot noise is larger than the PIN photodiode shot noise, and is given by the following equation.

$$I_n^2 = 2q(I_L + I_{dg})BM^2F + 2qI_{ds}B \dots (1-5)$$

- q: Electron charge
- I_L : Photocurrent at $M=1$
- I_{dg} : Dark current component to be multiplied
- I_{ds} : Dark current component not to be multiplied
- B: Bandwidth
- M: Multiplication ratio (gain)
- F: Excess noise factor

The excess noise factor F can be expressed by the multiplication ratio M and the ratio of the electron/hole ionization rate k,

as shown in Equation 1-6 below.

$$F = Mk + \left(2 - \frac{1}{M}\right) (1 - k) \dots (1-6)$$

Equation 1-6 shows the excess noise factor when electrons are injected into the avalanche region. To evaluate the excess noise factor when holes are injected into the avalanche region, k in Equation 1-6 should be substituted by $1/k$. In optimum conditions for minimizing the noise, k should equal 0 for electron injection and k should be infinite for hole injection. Si APDs are usually used in such a way that electrons are injected into the avalanche region, because they have a relation such that $\alpha \gg \beta$ ($k \ll 1$).

The excess noise factor F can also be approximated as $F=M^x$, because Equation 1-5 for shot noise can be expressed in a form of $I_n^2=2 qILBM^{2+x}$. The exponent x at this point is referred to as the excess noise index.

As explained earlier, APDs generate noise due to the multiplication process, so excess noise increases as the gain is increased. Since the gain exhibits wavelength-dependence, the excess noise differs according to the incident light wavelength. Similarly, the photocurrent generated by signal light is also amplified by the gain. These facts mean that the best S/N exists at a certain gain. The S/N for an APD can be calculated as follows.

$$S/N = \frac{I_L^2 M^2}{2q(I_L + I_{dg}) BM^2 F + 2qI_{ds} + \frac{4kTB}{R_L}} \dots (1-7)$$

where the first and second terms of the denominator are the shot noise, the third term is the thermal noise, k is the Boltzmann constant, T is the absolute temperature and R_L is the load resistance.

In PIN photodiode operation, using a larger load resistance can reduce the thermal noise, but this is not practical since a large load resistance slows the response speed. Therefore in most cases, thermal noise becomes a major factor in determining the lower limit of light detection. In APD operation in contrast, the S/N can be improved while maintaining the high-speed response, by increasing the gain until the shot noise reaches a level equal to the thermal noise. This is illustrated in Figure 1-5.

In the above case, the optimum gain M_{opt} at which the S/N in Equation 1-7 is maximized is given as follows, if I_{ds} can be ignored.

$$M_{opt} = \left[\frac{4kT}{q(I_L + I_{dg}) \cdot x \cdot R_L} \right]^{\frac{1}{2+x}} \dots (1-8)$$

Figure 1-5 Signal, noise vs. gain

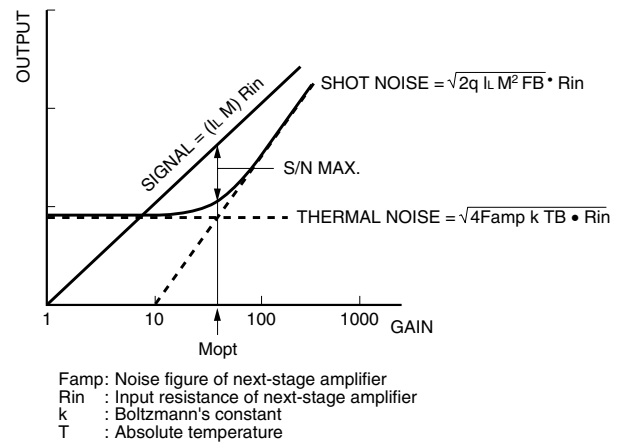

KAPDB0033EA

1-7 Response speed

The major factors that determine the response speed of a photodiode are the CR time constant and the carrier transit time in the depletion layer. For example, the cutoff frequency determined by the CR time constant is obtained as follows.

$$f_c(CR) = \frac{1}{2\pi C_t R_L} \dots (1-9)$$

where C_t is the terminal capacitance and R_L is the load resistance.

To increase the cutoff frequency, the terminal capacitance should be reduced, for example by making the active area smaller and the depletion layer thicker. A thicker depletion layer also enhances the quantum efficiency. The cutoff frequency f_c and the rise time t_r have the following relation.

$$t_r = \frac{0.35}{f_c(CR)} \dots (1-10)$$

On the other hand, if the depletion layer is widened, the transit time (drift speed) at which carriers move in the depletion layer cannot be ignored. The drift speed usually begins to saturate when the electric field strength reaches the vicinity of 10^4 V/cm, settling at around 10^7 cm/s. If the carrier transit time is t_{rd} , the following relation with the cut-off frequency f_c is established.

$$f_c(t_{rd}) = \frac{0.44}{t_{rd}} \dots (1-11)$$

Making the depletion layer thicker to reduce the terminal capacitance has a trade-off effect in that it increases the carrier transit time.

As stated previously, the carriers passing through the ava-

avalanche region repeatedly collide with the crystal lattice, so a longer time is required to move a unit distance than that required to move in areas outside the avalanche region. This means that extra time is required for multiplication, which is longer at a higher gain. This multiplication time might be a problem when an APD is used at a gain of several hundred.

In addition to the CR time constant, carrier transit time in the depletion layer and multiplication time, another factor that affects the response speed is the time delay caused by carrier diffusion current from outside the depletion layer. This time delay by carrier diffusion is sometimes as large as several microseconds. These time delays are particularly prone to occur when the depletion layer is not wide enough with respect to the penetration depth of the incident light into the Si substrate. To ensure fast response speed, applying a reverse voltage by taking account of the light wavelength is necessary so that the depletion layer is sufficiently wide. (See Figure 1-4.)

When the incident light level is high and the resulting photocurrent is large, the attractive power of electron-hole pairs in the depletion layer serves to cancel out the electric field. This slows down the drift speed of carriers in the center of the p-layer, thus degrading the response speed. This is known as the space charge-effect and tends to occur when the incident light is interrupted.

1-8 Connection to peripheral circuits

APDs can be handled in the same manner as normal photodiodes except that a high reverse voltage is required. However, the following precautions should be taken because APDs are operated at a high voltage.

APDs consume a considerably larger amount of power during operation than that do PIN photodiodes. The power consumption is given by the product of the input signal \times sensitivity (e.g. 0.5 A/W at $\lambda=800$ nm) \times gain \times reverse voltage. To deal with this, a protective resistor should be added to the bias circuit or a current limiting circuit should be used.

A low-noise readout circuit usually has high impedance, therefore an excessive voltage higher than the supply voltage for the readout circuit may possibly damage the first stage. To prevent this, a protective circuit should be connected so that excessive voltage at the inputs are diverted to the power supply voltage line.

As stated above, APD gain changes depending on temperature. When an APD is used over a wide temperature range, it is necessary to use some kind of temperature offset to control the reverse voltage according to temperature or use temperature control to maintain the APD at a constant temperature.

When detecting low-level light signals, the lower detection limit is determined by the shot noise. If background light enters the

APD, then the S/N ratio may deteriorate due to the shot noise from high background light. Precautions for minimizing background light includes optical filters, better laser modulation and restricting the field of view. Figure 1-6 shows a typical peripheral circuit.

Figure 1-6 Typical peripheral circuit

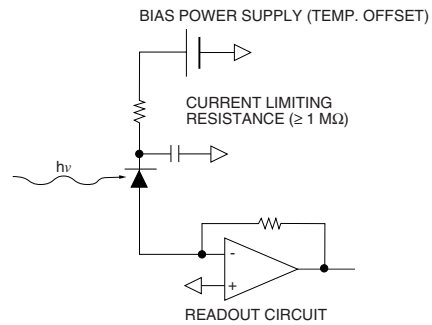

KAPDC0005EA

2. Near infrared Si APD (low-bias operation type, low temperature coefficient type)

In optical fiber communications and optical spatial communications, light in the 800 nm band is chiefly used. Hamamatsu provides Si APDs designed for light measurement in this near infrared wavelength range.

There are two types of near infrared Si APDs available: one is a low bias operation type that can be operated with a low reverse voltage; the other is a low temperature coefficient type that exhibits stable multiplication even if the ambient temperature fluctuates. The following sections explain the structure and characteristics of these APDs.

2-1 Structure

Figure 2-1 shows a cross section of a low bias operation type near infrared APD. This structure is called the reach-through type, having a PN junction between which a substrate p-layer (light absorption region) and a P-layer (avalanche region) are formed. Since the P-layer allows the electric field to easily concentrate on the PN junction, adequate gain can be obtained at a relatively low reverse voltage. The low temperature coefficient type APDs have the same structure, but with the P-layer in Figure 2-1 formed at an even deeper position.

Figure 2-1 Cross section of near infrared APD

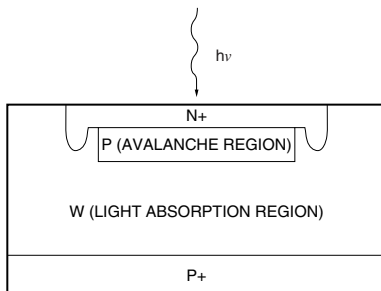

KAPDC0012EA

The active area can be chosen from $\phi 0.2$ mm to $\phi 5$ mm.

2-2 Dark current vs. reverse voltage

In Figures 2-2 and 2-3, typical dark current versus reverse voltage characteristics are plotted for different temperatures. Typical breakdown voltage differs depending on the APD type: 150 V for low bias operation types such as the S2381 series, and 200 V for low temperature coefficient types such as the S6045 series. The dark current temperature coefficient is approximately 1.08 times/ $^{\circ}$ C.

For the S2381, S2382, S2383 and S3884 series, specially se-

lected types with a breakdown voltage of 100 ± 20 V (-01 type), 140 ± 20 V (-02 type) and 180 ± 20 V (-03 type) are available.

Figure 2-2 Dark current vs. reverse voltage (S2382)

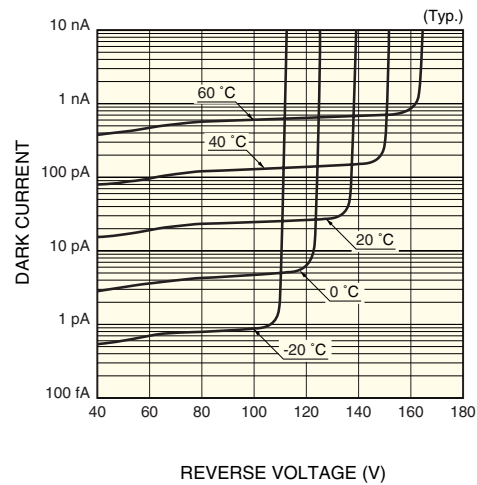

KAPDB0053EA

Figure 2-3 Dark current vs. reverse voltage (S6045-02)

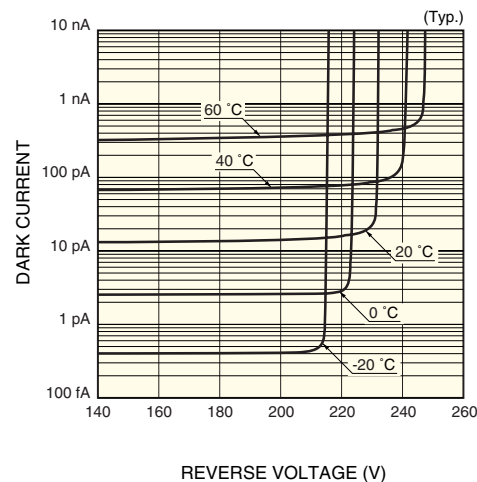

KAPDB0054EA

2-3 Gain vs. reverse voltage

Figures 2-4 and 2-5 show typical gain versus reverse characteristics for different temperatures. Near infrared APDs have the advantage that avalanche multiplication can be obtained at a low reverse voltage which is easy to control since the multiplication curve is relatively gentle.

The reverse voltage temperature coefficient is typically 0.6 to 0.7 V/ $^{\circ}$ C for low bias operation type and 0.4 V/ $^{\circ}$ C for low temperature coefficient type. However, this differs depending on whether the APD is used at a reverse voltage that fully depletes the p-layer (region in which the terminal capacitance is saturated) or at a lower reverse voltage. In the case of the S2381 series, for example, the temperature coefficient is roughly constant at the above value when used at 110 V or

Figure 2-4 Gain vs. reverse voltage (S2381 to S2385)

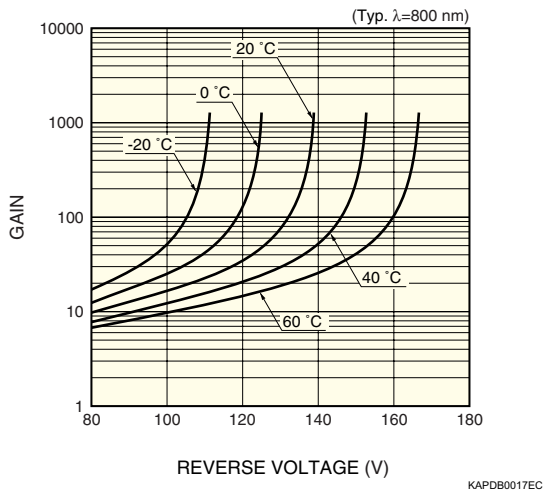
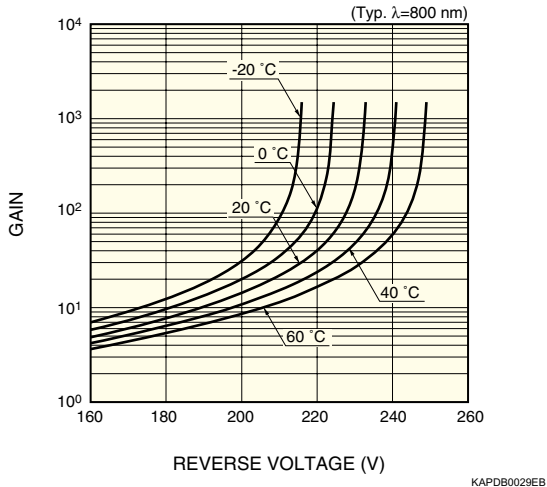
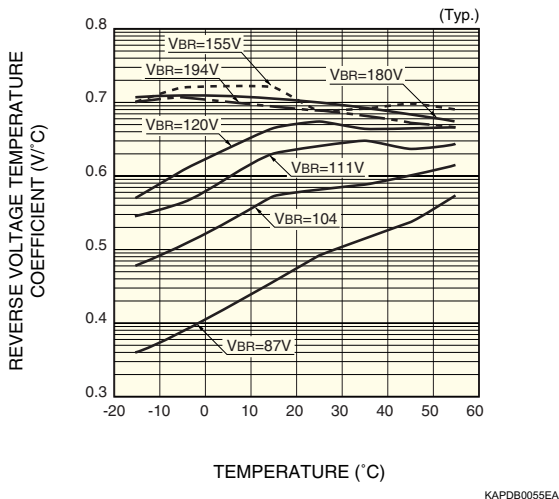

Figure 2-5 Gain vs. reverse voltage (S6045 series)



above, but it becomes smaller as the reverse voltage is decreased showing a reverse voltage dependence. (See Figure 2-6.) Accordingly, when temperature control is performed over a wide temperature range (especially on the low temperature

Figure 2-6 Temperature coefficient vs. reverse voltage (S2381)



side), use of a low temperature coefficient type APD (S6045 series) is recommended. At a reverse voltage higher than 150 V, the S6045 series APDs have a constant temperature coefficient which is smaller than the low bias operation type APDs, allowing stable measurement over a wide temperature range.

2-4 Spectral response

The light absorption region of near infrared Si APDs is formed at a position deeper than the avalanche region, as shown in Figure 2-1. This means that efficient avalanche multiplication is performed on long wavelength light which penetrates deep into the substrate. However, adequate multiplication is not performed when short wavelength light enters this type of APD.

Figure 2-7 Spectral response

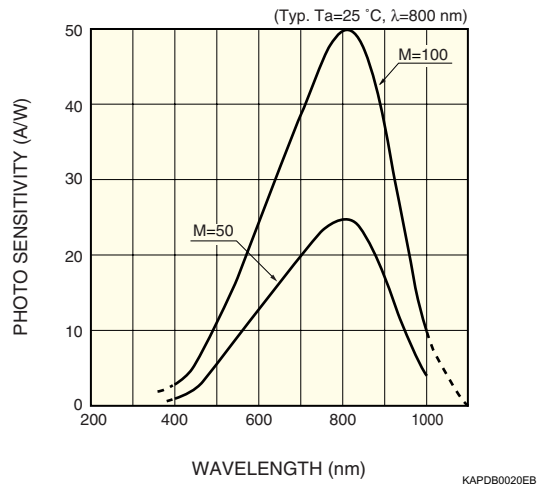
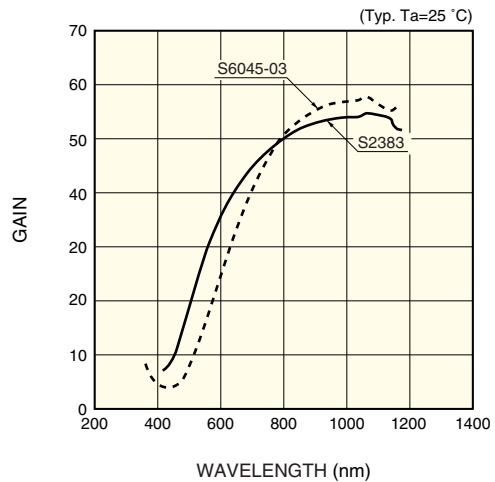

Figure 2-8 shows how the gain at a certain reverse voltage varies with wavelength. The gain is low at short wavelengths even when the same reverse voltage is applied to the APD. Therefore, satisfactory characteristics may not be obtained in this range. We recommend using short-wavelength type APDs in applications where wavelengths shorter than 600 nm must be detected.

Figure 2-8 Gain vs. wavelength



2-5 Terminal capacitance

Figures 2-9 and 2-10 show typical terminal capacitance versus reverse voltage characteristics of near infrared APDs. The flat portion on each curve (at above 110 V for the S2381 series and above 150 V for the S6045 series) is the region where the p-layer is fully depleted. Using each APD in this region is recommended to ensure high-speed response.

Figure 2-9 Terminal capacitance vs. reverse voltage (low-bias operation type)

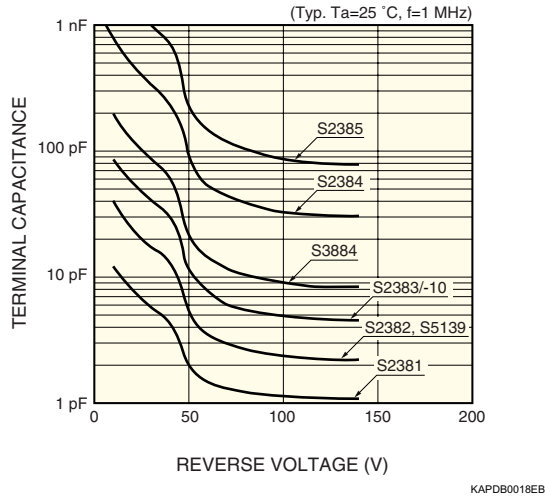
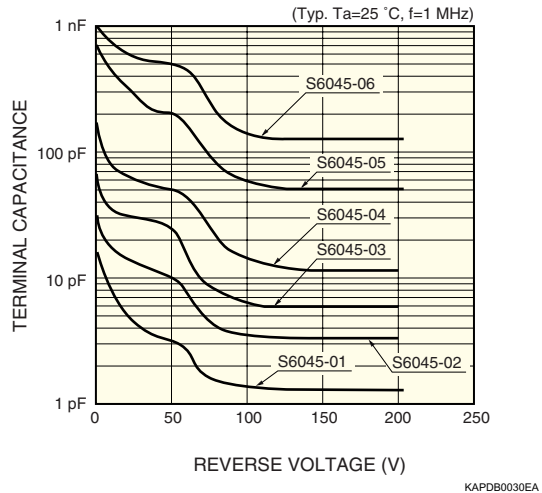

Figure 2-10 Terminal capacitance vs. reverse voltage (low temperature coefficient type)



2-6 Noise

Just as with spectral response characteristics, near infrared APD noise is dependent on the incident light wavelength. This is mainly because a higher electric field is required to maintain gain sufficient for detecting wavelengths which do not penetrate into the light absorption region. Consequently, the ratio of hole multiplication in the avalanche region increases and thus fluctuations in the multiplication process tend to occur.

Figure 2-11 Excess noise factor vs. gain (S2381 to S2385)

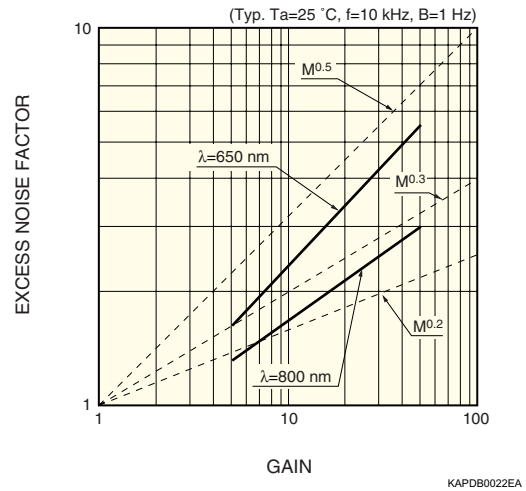

The excess noise index x is approximately 0.3 when the incident light wavelength is 800 nm, and approximately 0.5 when the incident light wavelength is 650 nm.

2-7 Frequency response

The APD frequency response depends on the reverse voltage. Figure 2-12 shows a typical example of how the cutoff frequency changes with the reverse voltage, along with changes in gain.

Figure 2-12 Gain, cut-off frequency vs. reverse voltage (S2383)

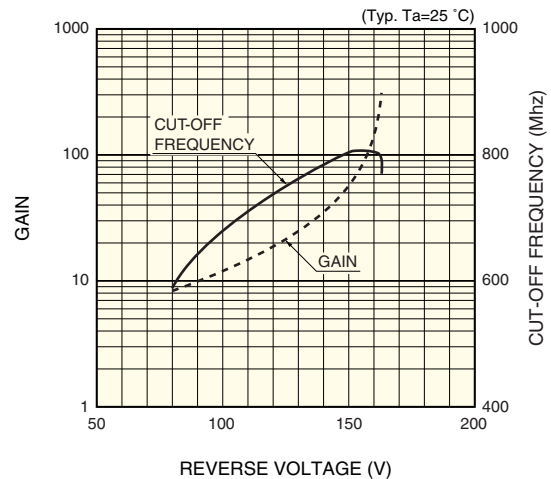

3. Short-wavelength type Si APD

Near infrared Si APDs are ideally suited for optical communications but not recommended for applications where wavelengths shorter than visible light are measured, particularly in high-precision photometry such as spectroscopy, because of limited gain and relatively high noise levels. For such applications, Hamamatsu provides short-wavelength type Si APDs that deliver satisfactory gain with low noise to detect light wavelengths shorter than visible light.

3-1 Structure

Figure 3-1 shows a cross section of a short-wavelength type Si APD. In contrast to the near infrared APDs, this structure is designed to receive light from the P-layer side. The light absorption region is formed near the device surface side, and the avalanche region is formed at a deeper position. An active area can be chosen in sizes of $\phi 1$ mm, $\phi 3$ mm or $\phi 5$ mm.

Figure 3-1 Cross section of short-wavelength type Si APD

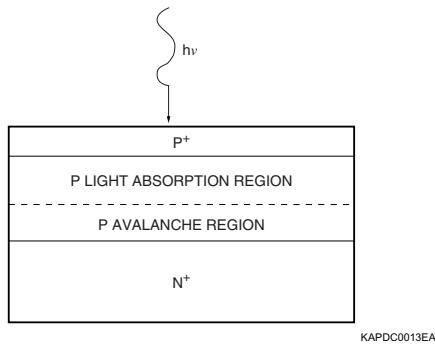

3-2 Dark current vs. reverse voltage

Figure 3-2 shows typical dark current versus reverse voltage characteristics. Typical breakdown voltage is 150 V as seen from the figure.

Figure 3-2 Dark current vs. reverse voltage

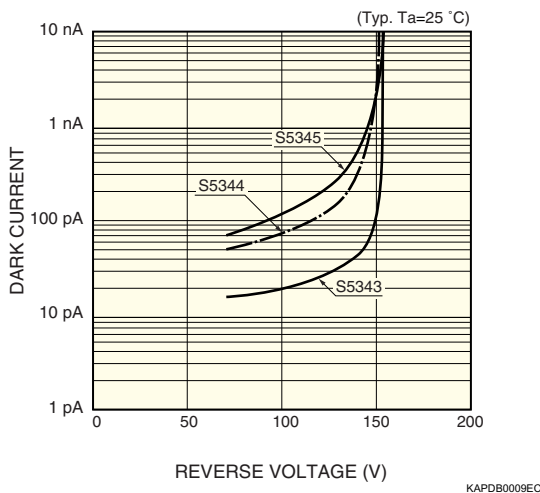

3-3 Gain vs. Reverse voltage

Typical gain versus reverse voltage characteristics at different temperatures are plotted in Figure 3-3. Since each curve exhibits a relatively sharp slope, practical gain is limited to about 50 times, which is lower than in near infrared APDs.

Figure 3-3 Gain vs. reverse voltage (S5343, S5344, S5345)

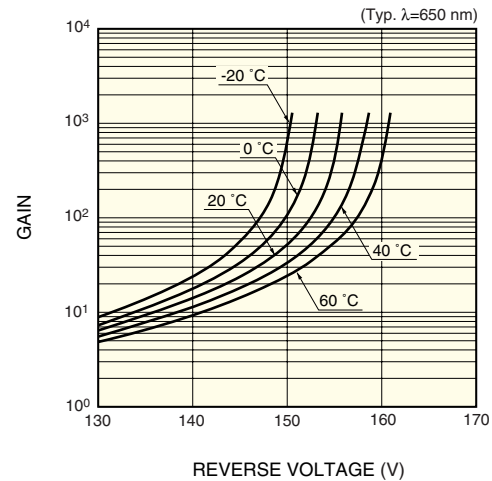

The reverse voltage temperature coefficient is as small as 0.14 V/°C. The reverse voltage level that fully depletes the depletion layer is approximately 90 V, and at a reverse voltage higher than this level, the temperature coefficient becomes nearly constant, permitting easy gain control over a wide temperature range.

Because the light absorption region of short-wavelength type APDs is formed near the device surface, long wavelength light tends to pass through it without contributing to the gain. This is the reverse of near infrared APD characteristics.

Figure 3-4 Spectral response (S5343, S5344, S5345)

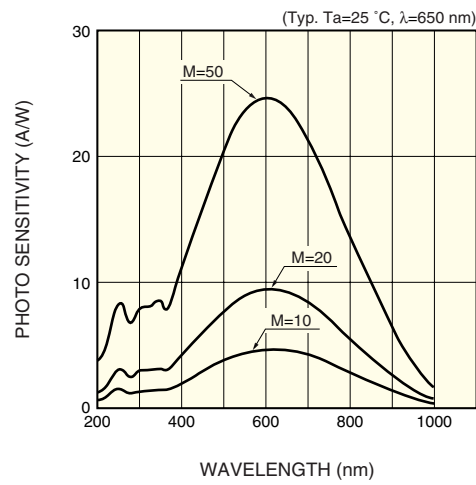

3-4 Spectral response

Short-wavelength type APDs have a peak response at 620 nm wavelength, with high sensitivity extending to the ultraviolet range. As the gain versus wavelength characteristics in Figure 3-5 show, good gain can be obtained in a spectral range shorter than the peak response wavelength.

Figure 3-5 Gain vs. wavelength

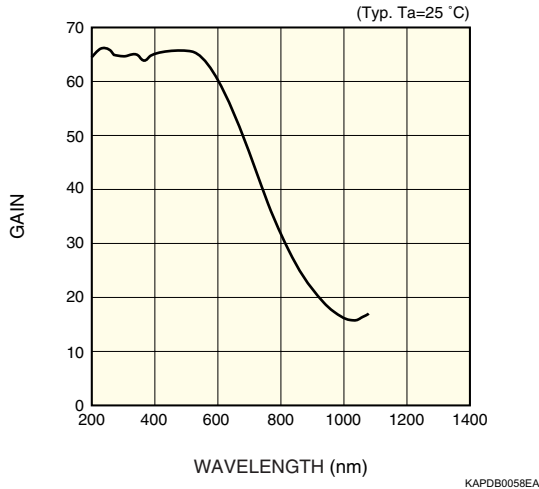

3-5 Terminal capacitance

Figure 3-6 shows typical terminal capacitance versus reverse voltage characteristics of short-wavelength type APDs. The flat portion on each curve is obtained at about 90 V or higher. This is a region where the P-layer is fully depleted. Using APDs in this region is recommended to ensure high-speed response.

Figure 3-6: Terminal capacitance vs. reverse voltage

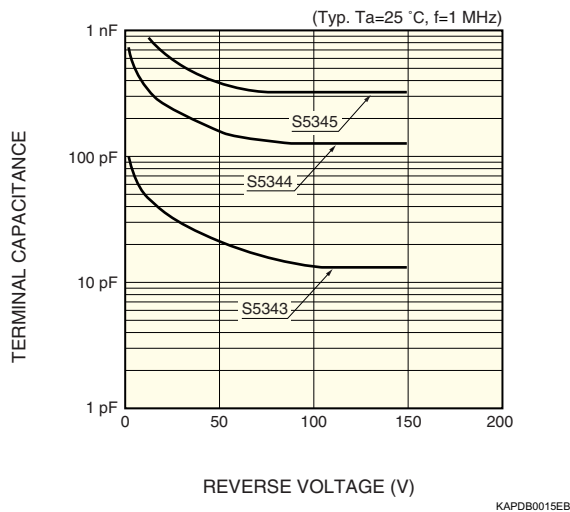

3-6 Noise

Just as with spectral response characteristics, short-wavelength APD noise is dependent on the incident light wavelength. This is because sufficient multiplication cannot be obtained with long wavelength light which penetrates deep into the substrate though the light absorption layer formed near the substrate surface. Figure 3-7 shows the relation between gain and excess noise factor at 650 nm and 800 nm wavelengths. This performance is the reverse of that observed with near infrared APDs.

Figure 3-7 Excess noise factor vs. gain

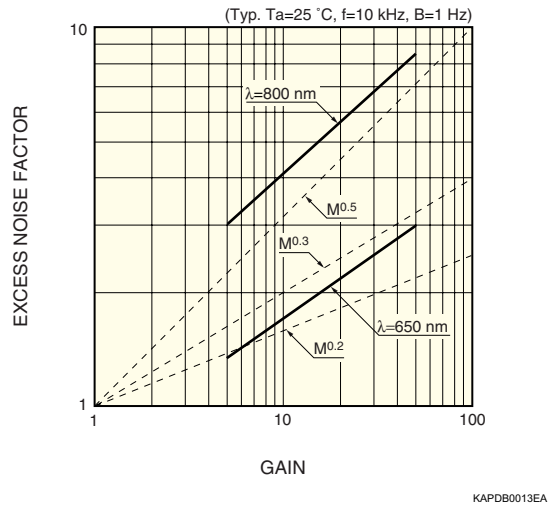

HAMAMATSU

Information furnished by HAMAMATSU is believed to be reliable. However, no responsibility is assumed for possible inaccuracies or omissions. Specifications are subject to change without notice. No patent rights are granted to any of the circuits described herein. ©2004 Hamamatsu Photonics K.K.

HAMAMATSU PHOTONICS K.K., Solid State Division

1126-1 Ichino-cho, Hamamatsu City, 435-8558 Japan, Telephone: (81) 053-434-3311, Fax: (81) 053-434-5184, <http://www.hamamatsu.com>

U.S.A.: Hamamatsu Corporation: 360 Foothill Road, P.O.Box 6910, Bridgewater, N.J. 08807-0910, U.S.A., Telephone: (1) 908-231-0960, Fax: (1) 908-231-1218

Germany: Hamamatsu Photonics Deutschland GmbH: Arzbergerstr. 10, D-82211 Herrsching am Ammersee, Germany, Telephone: (49) 08152-3750, Fax: (49) 08152-2658

France: Hamamatsu Photonics France S.A.R.L.: 8, Rue du Saule Trapu, Parc du Moulin de Massy, 91882 Massy Cedex, France, Telephone: 33-(1) 69 53 71 00, Fax: 33-(1) 69 53 71 10

United Kingdom: Hamamatsu Photonics UK Limited: 2 Howard Court, 10 Tewin Road, Welwyn Garden City, Hertfordshire AL7 1BW, United Kingdom, Telephone: (44) 1707-294888, Fax: (44) 1707-325777

North Europe: Hamamatsu Photonics Norden AB: Smidesvägen 12, SE-171 41 Solna, Sweden, Telephone: (46) 8-509-031-00, Fax: (46) 8-509-031-01

Italy: Hamamatsu Photonics Italia S.R.L.: Strada della Moia, 1/E, 20020 Arese, (Milano), Italy, Telephone: (39) 02-935-81-733, Fax: (39) 02-935-81-741